

15FP23

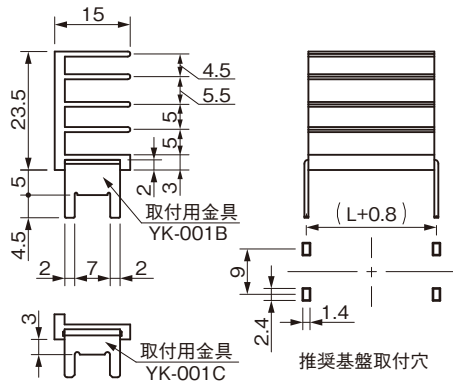

単位重量：0.319kg/m



L寸	熱抵抗 (°C/W)
L=100	7.2
L=150	5.2

— L=100
— L=150

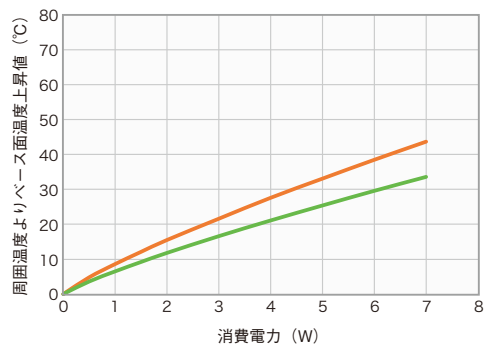

15FP32

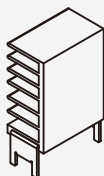

単位重量：0.437kg/m

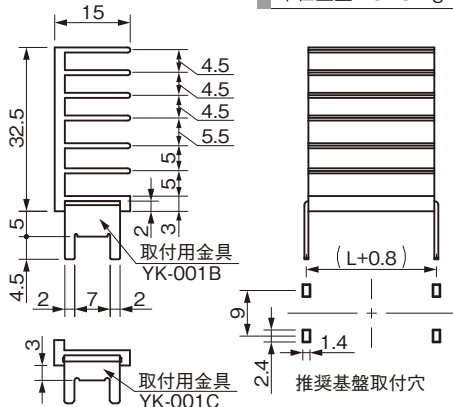

L寸	熱抵抗 (°C/W)
L=50	9.2
L=100	5.4
L=150	3.9

— L=50
— L=100
— L=150

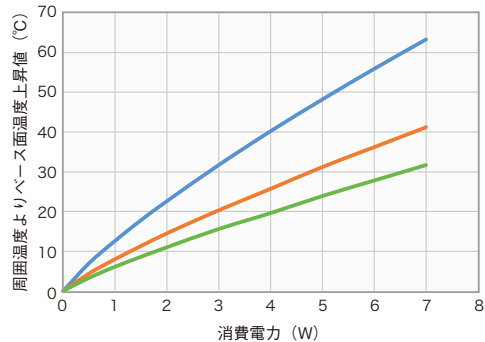

15FP35



単位重量：0.380kg/m

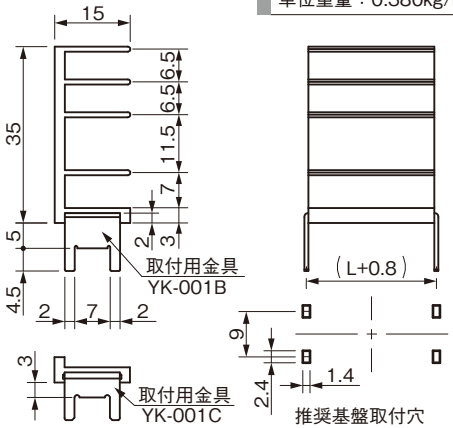

L寸	熱抵抗 (°C/W)
L=50	8.8
L=100	7.0
L=150	5.1

— L=50
— L=100
— L=150

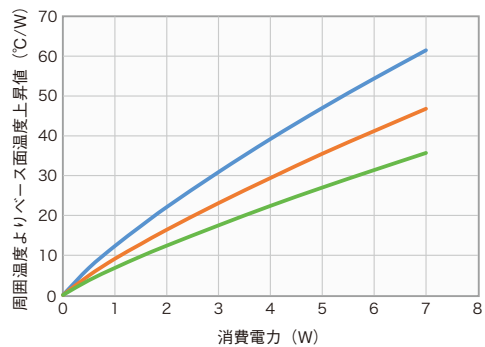

15FP45

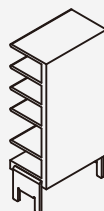

単位重量：0.470kg/m

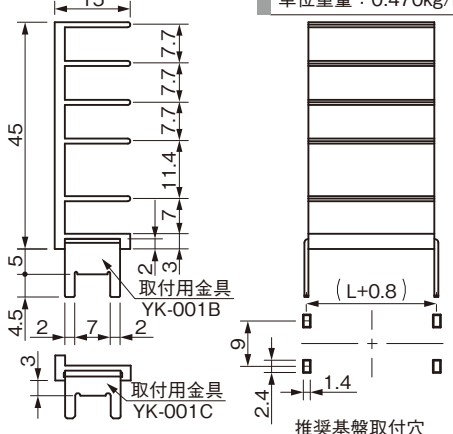

L寸	熱抵抗 (°C/W)
L=50	5.7
L=100	4.8
L=150	3.4

— L=50
— L=100
— L=150

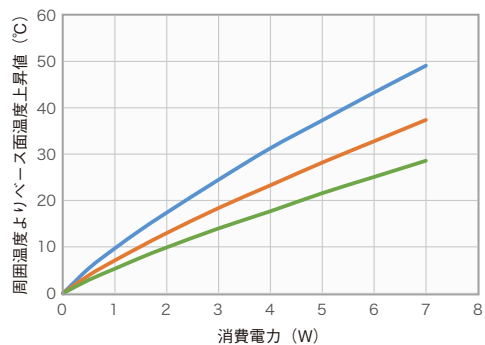

15FP55

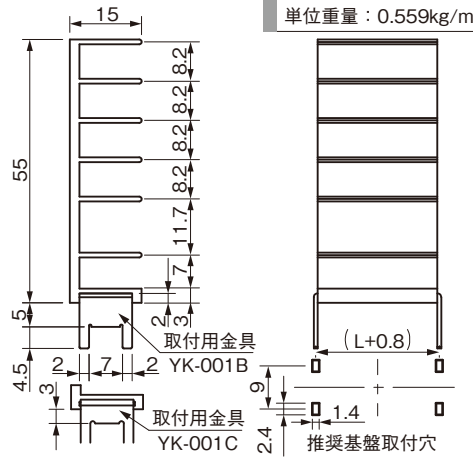
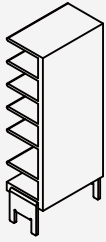

L寸	熱抵抗 (°C/W)
L=50	5.8
L=100	4.2
L=150	3.0

— L=50
— L=100
— L=150

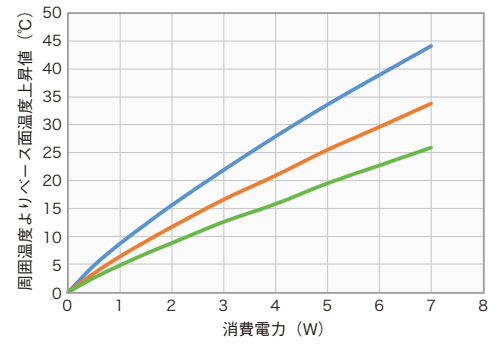

端子寸法

